

Accelerometer | os7100

Applications

- Measurement of acceleration on large structures from DC to low frequencies.
- Continuous lifetime health monitoring of bridges, dams, buildings, tunnels, ships, aircraft, trains, and other complex structures.

Features

- Qualified to same rigorous standards applied to comparable electronic gages.
- Cable integrated with sensor package for fiber protection and strain relief.
- Standard threaded connection to structure for fast, simple, repeatable installation.
- Available mounting block for two and three axis applications.
- Connector protection fittings available for harsh environments.
- Armored fiber cable and rugged sensor package.
- Micron Optics' patented micro opto-mechanical technology.

Description

The os7100 is a fiber optic accelerometer based on Fiber Bragg Grating (FBG) technology.

Optimized for large structures and long term measurements, the os7100 measures accelerations from DC up to a few hundred Hertz. Like most conventional accelerometers, the os7100 can be attached to a structure using a standard threaded connection, and is available in one, two or three axis configurations. A rugged, sealed metallic body, armored cables, available weatherproof junction boxes and connector protection fittings make the os7100 ideal for outdoor installations on exposed structures.



os7100 - Single Axis Accelerometer

For low frequency signals, the os7100 yields measurements that are as accurate and stable as conventional accelerometers and offers the added benefits of EMI immunity and lightning/corrosion resistance that are needed for long term outdoor installations. Additionally, the os7100 is inherently compatible with FBG based strain and temperature sensors, thereby enabling comprehensive fiber-based sensing networks.

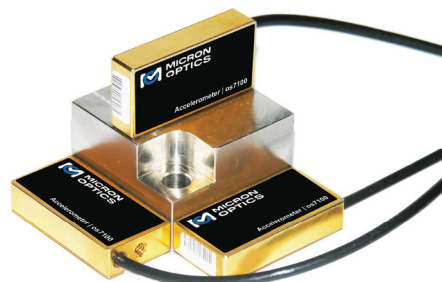

os7100 - Three Axis Accelerometer

The os7100's single-ended design is ideally deployed in coupled-star sensor network architectures, thus maximizing overall sensor capacity on each optical sensing interrogator channel. Installation and cabling requirements for these types of fiber arrays are much less expensive and easier to manage than those of conventional electronic sensor networks.

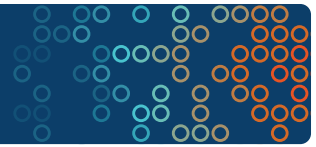

Specifications ¹

os7100

Performance Properties

Operating Temperature Range	-40 to 80°C
Reference Sensitivity ²	~16 pm/g
Frequency Response	See charts below
Frequency Range ³	DC to 300 Hz
Mounted Resonance Frequency	~700 Hz
Transverse Sensitivity	< 5% Reference Sensitivity
Temperature Transient Sensitivity	10.7 ms ⁻² /°C
Maximum Operational Shock	100 g Peak

Physical Properties

Dimensions ⁴	38 x 9 x 19 mm
Weight ⁴	28 g
Case Material / Plating	ASTM F-15 Kovar/Gold over electrolytic nickel
Cable Length	User specified, 1 m max (± 10 cm)
Fiber Type	SMF28-Compatible
Cable Bend Radius	≥ 17 mm
Cable Type	3 mm Armored Cable
Connectors	FC/APC optional
Mounting Method ⁵	10-32 Tapped Hole

Optical Properties

Peak Reflectivity (Rmax)	> 70%
FWHM (-3 dB point)	0.25 nm (± .05 nm)
Isolation	> 15 dB (@ ± 0.4 nm around center wavelength)

Notes:

1. Denotes Beta product. For more details see www.micronoptics.com/product_designation.php.
2. At 159.2 Hz ($\omega = 1000$ Hz), 20 m/s RMS and 24°C.
3. Aliasing can occur for frequencies > 0.5 the sampling frequency.
4. Excluding cable.
5. 3D mounting block available for 2 and 3 axis applications. See http://www.micronoptics.com/support_downloads/Sensors/ for sensor drawings and installation details.

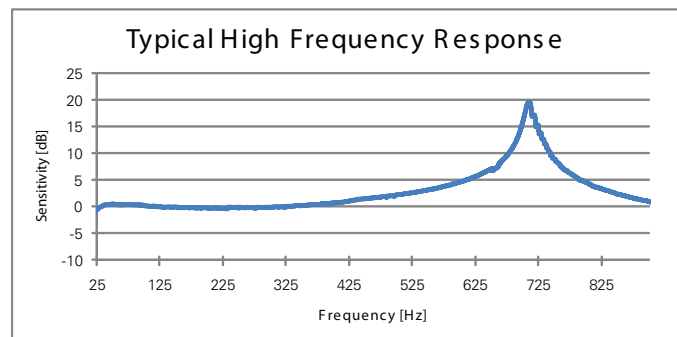
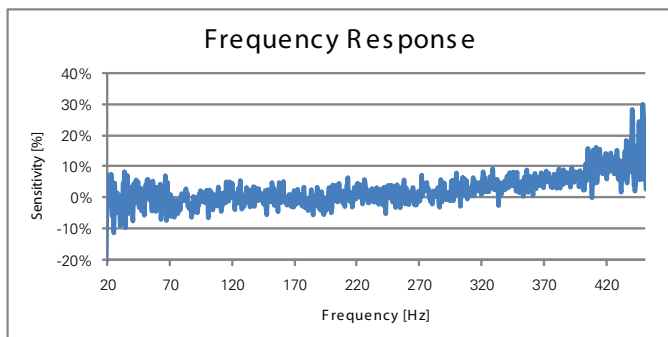

Example A: os7103-MB-1516/1520/1524[0.5CB-0.5CB-0.7CB-0.4PF]-C4-15.5PF - three axis accelerometer with mounting block, extra end with protection fitting, 1x4 coupler box, protection fitting on cable from coupler box.

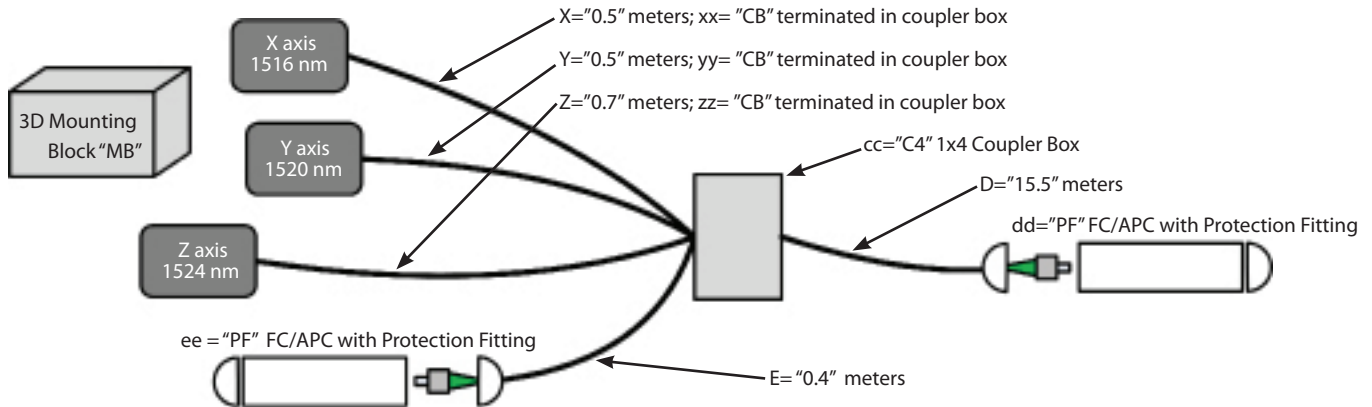

Example B: os7102-MB-1528/0000/1548[1CB-000-1CB-1FC]-C3-33UT - two axis accelerometer with mounting block, extra end with FC/APC connector, 1x3 coupler box, no termination on cable from coupler box.

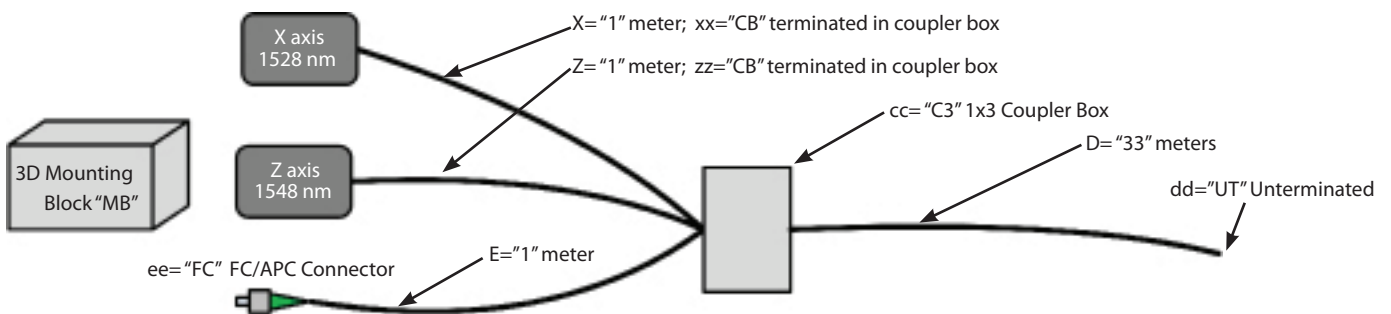

Example C: os7101-00-1560/0000/0000[1UT-000-000-000]-00-000 - one axis accelerometer, no mounting block, no extra end, no coupler box, no termination on cable from accelerometer.

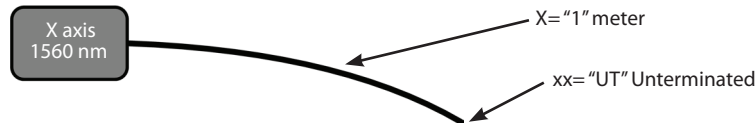

Ordering Information

os710a-bb-[www](#)/[www](#)/[www](#)[Xxx-Yyy-Zzz-Eee]-cc-Ddd

a: Model 1 One Axis 2 Two Axis 3 Three Axis	bb: Mounting Block 00 No Block (standard for single axis) MB Mounting Block (standard for two and three axis)	www: Wavelength(s) for x/y/z Axes (± 1 nm) Standard: 1516 to 1588nm in 4nm intervals. Extended: 1460 to 1620nm Note: allow at least 4nm between each axis Note: enter 0000 if no Y or Z axis	X, Y, Z: os7100 Cable Length Note: in meters, 1 m max. ± 10 cm xx, yy, zz: Termination Type 000 No Cable, Axis not Used CB Terminated in Coupler Box UT Underterminated FC FC/APC Connector PF FC/APC Connector with Protection Fitting
E: "Extra End", Cable Length from Coupler Box to Termination Note: in meters ± 10 cm ee: Termination Type 000 No Extra End UT Underterminated FC FC/APC Connector PF FC/APC Connector with Protection Fitting	cc: Coupler Box 00 No Coupler Box C2 1x2 NEMA 4X Coupler Box C3 1x3 NEMA 4X Coupler Box C4 1x4 NEMA 4X Coupler Box	D: Cable Length from Coupler Box to End Note: in meters ± 10 cm; enter Ddd=000 if cc=00 dd: Termination Type UT Underterminated FC FC/APC Connector PF FC/APC Connector with Protection Fitting	

